

# NORDCEL



## ***Owner's Manual*** ***Original Instructions***

Air Source Heat Pump Water Heater

Models:  
NGRS-S3.5PdG

Thank you for choosing this product. Please read this Owner's Manual carefully before operation and retain it for future reference.



# To Users

Thank you for selecting NORDCEL's product. Please read this instruction manual carefully before installing and using the product, so as to master and correctly use the product. In order to guide you to correctly install and use our product and achieve expected operating effect, we hereby instruct as below:

- (1) This appliance is not intended for use by persons (including children) with reduced physical, sensory or mental capabilities, or lack of experience and knowledge, unless they have been given supervision or instruction concerning use of the appliance by a person responsible for their safety. Children should be supervised to ensure that they do not play with the appliance.
- (2) In order to ensure reliability of product, the product may consume some power under stand-by status for maintaining normal communication of system and preheating refrigerant and lubricant. If the product is not to be used for long, cut off the power supply; please energize and preheat the unit in advance before reusing it.
- (3) Please properly select the model according to actual the using environment, otherwise it may impact the using convenience.
- (4) This product has gone through strict inspection and operational test before leaving the factory. In order to avoid damage due to improper disassembly and inspection, which may impact the normal operation of unit, please do not disassemble the unit by yourself. You can contact with the special maintenance center of our company if necessary.
- (5) When the product is faulted and cannot be operated, please contact with our maintenance center as soon as possible by providing the following information.
  - 1) Contents of nameplate of product (model, cooling/heating capacity, product No., ex-factory date).
  - 2) Malfunction status (Specify the situations before and after the error occurs).
- (6) All the illustrations and information in the instruction manual are only for reference. In order to make the product better, we will continuously conduct improvement and innovation. We have the right to make necessary revision to the product from time to time due to the reason of

sales or production, and reserve the right to revise the contents without further notice.

- (7) The final right to interpret for this instruction manual belongs to NORDCEL.

## Exception Clauses

Manufacturer will bear no responsibilities when personal injury or property loss is caused by the following reasons:

- (1) Damage the product due to improper use or misuse of the product;
- (2) Alter, change, maintain or use the product with other equipment without abiding by the instruction manual of manufacturer;
- (3) After verification, the defect of product is directly caused by corrosive gas;
- (4) After verification, defects are due to improper operation during transportation of product;
- (5) Operate, repair, maintain the unit without abiding by instruction manual or related regulations;
- (6) After verification, the problem or dispute is caused by the quality specification or performance of parts and components that produced by other manufacturers;
- (7) The damage is caused by natural calamities, bad using environment or force majeure.

# Contents

1 Safety Notices (Please be sure to abide).....	1
2 Models and Technical Specifications .....	6
3 Working Principles and Advantages.....	9
3.1 Schematic Diagram of the Air Source Water Heater.....	9
3.2 Brief Introduction to Principles.....	9
3.3 Advantages .....	9
4 Installation Precautions.....	11
4.1 Importance Notes .....	11
4.2 Basic Requirements for Installation Sites.....	12
5 Main Unit Installation .....	12
5.1 Location for Installing the Main Unit.....	12
5.2 Space Requirement for Main Unit Installation .....	12
6 Installation of the Water Tank.....	14
7 Pipeline Connection.....	15
7.1 Refrigerant Pipe Connection .....	15
7.2 Exhaust Methods.....	17
7.3 Water Pipe Connection.....	19
8 Installation Diagram of the Unit.....	22
9 Wiring .....	23
9.1 Wire Layout.....	23
9.2 Wire Connections .....	25
10 Wired Controller Installation.....	26
10.1 Requirements for Wired Controller Installation Locations.....	26
10.2 Wired Controller Installation .....	27
10.3 Rainproof Box Installation .....	28
11 Commissioning .....	30
12 Methods for Replenishing or Discharging Refrigerants....	31
12.1 Refrigerant Replenishment.....	31
12.2 Refrigerant Discharging.....	32
13 Method for Refrigerant Reclamation .....	33
14 Performance of the Unit.....	34
14.1 Heating Capacity .....	34
14.2 Operating Performance .....	35
15 Operation Notices in winter.....	36
16 Maintenance .....	37

16.1 Water Input and Drainage of Water Tank .....	37
16.2 Periodic Cleaning for Water Tank.....	37
16.3 Replacement of magnesium rod .....	38
16.4 Safety Valve Maintenance .....	39
16.5 Maintenance of the Unit .....	39
17 Precautions for Safety Usage .....	40
18 Malfunction Analysis .....	41

# 1 Safety Notices (Please be sure to abide)



**WARNING:** If not abide strictly, it may cause severe damage to the unit or the people.



**NOTICE:** If not abide strictly, it may cause slight or medium damage to the unit or the people.



This sign indicates that the operation must be prohibited. Improper operation may cause severe damage or death to people.



This sign indicates that the items must be observed. Improper operation may cause damage to people or property.











## **WARNING!**





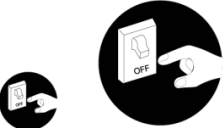

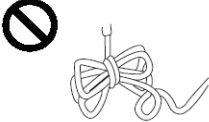
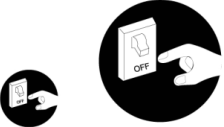

This product can't be installed at corrosive, inflammable or explosive environment or the place with special requirements, such as kitchen. Otherwise, it will affect the normal operation or shorten the service life of the unit, or even cause fire hazard or serious injury. As for the special places above, please adopt special product with anti-corrosive or anti-explosion function.

Air source water heater is a thermal storage water heater. The user shall open the cold water valve first, then adjusting cold and hot water flow to proper water temperature gradually to avoid scald injury. If not using the unit in winter in short time, please ensure that it is energized for the whole 24h, if not unit using the unit for a long period, discharge water in water tank and pipeline in case the system is frosted. If you think the discharge operation is inconvenient, please directly contact our local distributors or authorized service branch, we will appoint special staff to provide inspection, debug, cleaning and maintenance services.





This manual is the usage and installation manual for unitary air source water heater. Usage method for display shall refer to the attached Display Manual.



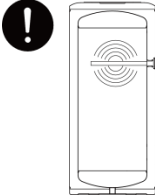
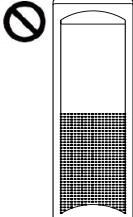

-  Water tank must install TP valve as required, the TP valve provided by user;
-  Try to use tap water, avoid not using well water or river water;
-  To guarantee water quality, clean the water tank periodically as required;
-  Water tank shall be installed in places without rainwater. If not, take rain-proof measures.

NO.	Safety Notices	Graphic symbol
1	<p>★ Once abnormality like burning smell occurs, please cut off the power supply immediately and then contact with service center.</p> <p>If the abnormality still exists, the unit may be damaged and electric shock or fire may result.</p>	
2	<p>★ Don't operate water heater with wet hand. Otherwise, it may cause electric shock.</p>	
3	<p>★ Before installation, please see if the voltage of local place accords with that on nameplate of unit and capacity of power supply, power cord or socket is suitable for input power of this unit.</p>	
4	<p>★ Special circuit must be adopted for power supply to prevent fire.</p> <p>Do not use octopus multipurpose plug or mobile terminal board for wire connection.</p>	
5	<p>★ Be sure to pull out the power plug and drain the main unit and water tank when water heater is not in use for a long time.</p> <p>Otherwise, the accumulated dust may cause overheating, fire or freeze of water tank or coaxial heater exchanger in winter.</p>	
6	<p>★ Never damage the electric wire or use the one which is not specified.</p> <p>Otherwise, it may cause overheating or fire.</p>	

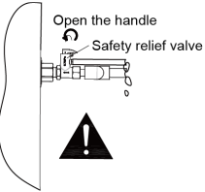
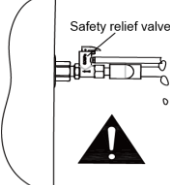
NO.	Safety Notices	Graphic symbol
7	<p>★ Before to clean, please cut off the power supply. Otherwise, an electric shock hazard may be caused.</p>	
8	<p>★ The power supply must adopt special circuit with leakage switch and enough capacity.</p>	
9	<p>★ This appliance is not intended for use by persons (including children) with reduced physical, sensory or mental capabilities, or lack of experience and knowledge, unless they have been given supervision or instruction concerning use of the appliance by a person responsible for their safety. Children should be supervised to ensure that they do not play with the appliance.</p>	
10	<p>★ Earthing: the unit must be earthed reliably! The earthing wire should connect with special device of buildings. If not, please ask the qualified personnel to install. Furthermore, don't connect earth wire to gas pipe, water pipe, drainage pipe or any other improper places which professional does not recognize.</p>	
11	<p>★ Do not put any foreign matter into the unit, otherwise it would cause the unit being damaged or result in danger. Never put your hands at the air outlet of the unit.</p>	
12	<p>★ Do not repair the unit by yourself, in case of electric shocks or fire hazards. Please contact the NORDCEL appointed service center.</p>	
13	<p>★ Do not step or place objects on the unit, as they would be injured or damaged when falling off.</p>	
14	<p>★ Do not block the air inlet of the unit, otherwise it would reduce the efficiency of the unit, stop it, or even result in fire hazards.</p>	

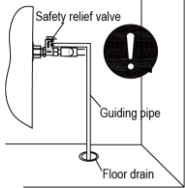
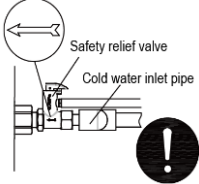
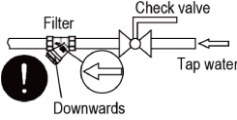
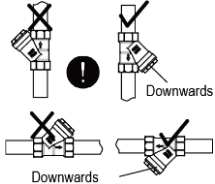

NO.	Safety Notices	Graphic symbol
15	<p>★ Check whether the base of the main unit is damaged. If the base is damaged and not fixed, the unit may fall off, causing hazards.</p>	
16	<p>★ Keep the chemical spray, gas tank or others similar at least 1m away from the unit, otherwise it would lead to fire hazards or explosion.</p>	
17	<p>★ To improve durability of the water tank, a Magnesium rod is installed inside the water tank. The Magnesium rod has a lifespan of two to three years, and must be replaced by professional maintenance personnel if a replacement is required.</p>	
18	<p>★ If thermal water tank has no water or water is not full, please do not energize the unit for startup, otherwise, it might damage the unit or result in fire hazard.</p>	
19	<p>★ It is highly recommended to place the unit where good ventilation is available.</p>	
20	<p>★ Check the safety relief valve for blockage periodically (about one month) by removing the hand grip and operate it periodically (about one year).</p>	
21	<p>★ It is a normal phenomenon that the safety relief valve drips.</p>	

NO.	Safety Notices	Graphic symbol
22	<p>★ The safety relief valve shall be got through to the floor drain through a flexible tube.</p>	
23	<p>★ The safety relief valve shall be installed properly with the direction arrow indicated the same direction as the cold water flow.</p>	
24	<p>★ It is recommended to install horizontally the filter downstream of the main cut-off valve of the user's water pipe. Please note that the direction arrow on the filter shall indicate the direction the same as the water flow. When it is required to remove impurity inside the water circuit, open the end cover of this filter.</p>	
25	<p>★ When the filter is installed vertically, the direction arrow can not be upward and the end cover shall be placed slantwise downwards.</p>	
26	<p>★ This marking indicates that this product should not be disposed with other household wastes throughout the EU. To prevent possible harm to the environment or human health from uncontrolled waste disposal, recycle it possibly to promote the sustainable reuse of material resources. To return you used device, please use the return and collection systems or contact the retailer where the product was purchased. They can take this product for environmental safe recycling.</p>	
27	<p>★ This unit contains fluorinated gas with greenhouse effect covered by the Kyoto Protocol. Maintenance and disposal must be carried out by qualified persons only. Refrigerant gas R410A, GWP=2088.</p>	
28	<p>★ The fuse model and rated value are in accordance with the corresponding controller or the silk screen attached on the protective tube.</p>	

## 2 Models and Technical Specifications

The air source water heater consists of an outdoor unit, a water tank, wired controller, a refrigerant pipe, and a water pipe. It provides hot water to users for household use.

The appearance of the main parts is shown in Figure 2-1. Actually, the appearance of the product may not be exactly the same as that shown in the figure. For the actual appearance, refer to the product delivered.

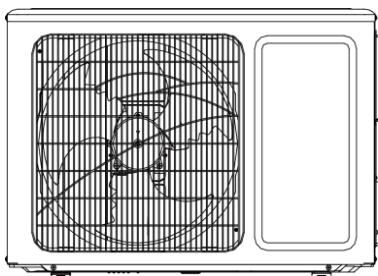

Outdoor unit



Wired controller

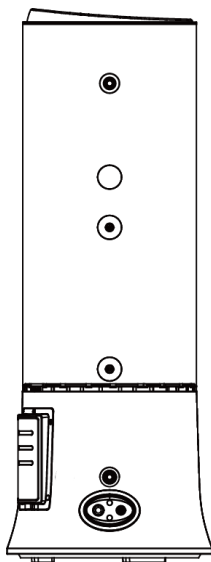

Water tank

Figure 2-1 Appearance of the main parts

This installation guide provides guidance on installation of the following model.

Table 2-1 Connection between the main unit and the water tank

Outdoor unit model	Water tank model
NGRS-S3.5PdG	NSXD200LCJW

During the installation, please comply with the model mapping in the preceding table. Otherwise, a fault may occur because the main unit mismatches the exchanger capacity of the water tank.

Table 2-2 Unit Model and Specification

Model		NGRS-S3.5PdG	
Rated Heating Capacity <sup>(*)</sup>	W	3500(1800~4000)	
Rated Input Power <sup>(*)</sup>	W	850(360~1333)	
COP <sup>(*)</sup>	W/W	4.10	
Load Profile	-	L	
COP <sub>DHW</sub> <sup>(**)</sup>	W/W	3.17	
Energy Efficiency Class <sup>(2)</sup>	-	A <sup>+</sup>	
Water Heating Energy Efficiency <sup>(2)</sup>	-	129%	
Annual electricity consumption (average climate conditions)	kWh	795	
Maximum Input Power	W	1500+1500W (Electric Heater)	
Outlet Water Temperature	°C	Default: 55°C, 35°C~55°C	
Power Supply	-	220V-240V ~50Hz	
Insulation Level	-	I	
Protection of Ingression	-	I PX4	
Refrigerant	Name		R410A
	Charge	kg	1.40
Outline Dimensions	W x D x H	mm	842×320×591
Package Dimensions	W x D x H	mm	948×363×660
Gross/Net Weight		kg	44.5/38.5
Sound Power Level <sup>(***)</sup>		dB(A)	63
Operating Range		°C	-25~45°C

Notes:

- (1) (\*) Value obtained with the following conditions: Outdoor temperature: 20°C DB/15°C WB; Water tank temperature (start/end): 15°C /55°C.
- (2) (\*\*) Value obtained with an air temperature of 7°C and a water inlet at 10°C, as per EN16147, (EU) No 814/2013.

- (3) (\*\*\*) Value obtained as per EN 12102-2008.
- (4) Under fast water heating mode, electric heater helps to heating water.
- (5) Please always see the nameplate for the exact data as this table is subject to change.

Table 2-3 Water Tank Model and Specification

Model		NSXD200LCJW
Capacity	L	185
Power Supply for Electric Heater	-	220V-240V~50Hz
Input Power for Electric Heater	W	1500
Outline Dimensions(W x D x H)	mm	545 x 545 x 1919
Package Dimensions(W x D x H)	mm	2009 x 656 x 625
Water Tank Gross/Net Weight	kg	60/52
Outer Size of Connection Pipe	mm	Φ6, Φ9.52

Notes: Please always see the nameplate for the exact data as this table is subject to change.

Table 2-3 Performance Data of Hot water Mode

Te (°C)	Mode	inlet water T1 (°C)	outlet water T2 (°C)	capability (kW)	COP (W/W)
45	Hot water	29	55	2.90	7.80
20		15	55	3.50	4.10
7		10	55	1.80	3.80
0		10	55	1.90	2.30
-7		10	55	2.40	2.20
-15		10	55	1.90	1.80
-20		10	55	1.40	1.50

### 3 Working Principles and Advantages

#### 3.1 Schematic Diagram of the Air Source Water Heater

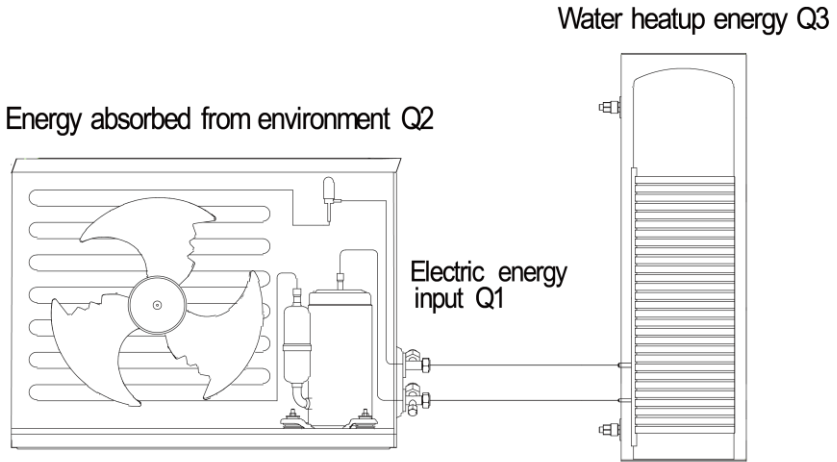

$$\text{Energy obtained from water } Q3 = \text{Energy absorbed from environment } Q2 + \text{Electric energy input } Q1$$

Figure 3-1 Schematic diagram of the air source water heater

#### 3.2 Brief Introduction to Principles

The air source water heater unit is designed based on the heat pump principles. It consumes a part of electric energy as a supplement, and by using the thermodynamic cycle, absorbs heat from the low-grade energy (air source) environment, and transfers the heat to a condenser through a compressor, and releases it to the water inside the water tank. In this way, the water is heated up.

The working principles of an air source water heater are the same as those of a heat pump air conditioner. A heat pump air conditioner absorbs heat from the natural environment and transfers it to the indoor air; however, the air source water heater uses the absorbed heat to heat up domestic water. The air source water heater is a novel, efficient, energy-saving, and environment-friendly heater product.

#### 3.3 Advantages

- (1) Efficient and Energy-Saving

The outdoor unit of this product adopts an electronic expansion valve for

adaptive control. It automatically adjusts its opening size based on the unit operating conditions, and uses the heat in the air to heat up domestic water, so that the unit always runs at optimal performance as well as ensuring reliability.

This unit adopts inverter 2-stage compressor and the capacity can realize stepless adjustment. EER is much higher and noise is lower under low-frequency operation; rapid heating can be realized under high-frequency operation. Heating capacity is improved by 40% above compared with common heat pump water heater.

The water tank adopts an externally wrapped microchannel heat exchanger, and is in planar contact with the inner container, which features higher efficiency in heat exchange and a high pressure-bearing capability. Effective thermally-conductive materials are used between the microchannel heat exchanger and the inner container of the water tank to enhance heat transfer.

In testing conditions of the unit, the coefficient of performance (COP) reaches up to 3.0, and the operating costs are more economical than conventional heaters.

### (2) Reliability and Durability

The unit adopts heap pump water heater specialized inverter 2-stage compressor, which provides a powerful heat for the air source water heater. The unit can produce 55°C hot water reliably under -25°C ultra-low ambient temperature.

The insulated water tank adopts the advanced stainless steel inner port, equipping with the anticorrosive design for the super-long magnesium. The complete unit is with multiple kinds of protection.

### (3) Simple and Convenient Installation

The installation is not subject to any environmental limitation. The unit can be installed in the kitchen, balcony, garage, storage room, or basement according to actual living conditions, and requires no special care. It applies to places such as household use and villa suites. It is a no-loop waterway system, and can be easily and conveniently installed.

### (4) Luxury Configurations

The unit is equipped with a high-end ultra-thin touch-wired controller, which

provides five heating modes: Hot water, Save, Preset, Night and E-heater modes. The unit provides a proper water temperature range from 35°C to 55°C. It provides functions such as timer switch, "Rapid" and "i-know".

### (5) Intelligent Defrosting

The unit provides the antifreeze and automatic defrosting functions, which effectively solve the problems such as heat exchanger freezing, frosting, and sewage caused by defrosting.

### (6) All-Weather Applicable

Supplies hot water all year round regardless of nights or rainy weather.

## 4 Installation Precautions

### 4.1 Importance Notes

- (1) The air source water heater must be installed by professional personnel by abiding by the national wiring code and following the instructions in this guide.
- (2) For installation or migration of the air source water heater, please contact your local service centers authorized by NORDCEL. In the case of an air source water heater installed by any party not authorized or designated by NORDCEL, NORDCEL shall not undertake any responsibility for any fault or problems caused the air source water heater.
- (3) If the user installs the air source water heater using self-prepared installation materials, NORDCEL shall not undertake any responsibility for any loss caused by improper running and use of the air source water heater due to pipe leakage, fall-off, or insecure installation.
- (4) The quality of water heated by the air source water heater meets the local drinking water health standards. If well water, groundwater, and seawater are used, the depletion of the Mg-Stick in the water tank may be accelerated, thereby shortening the lifespan of the unit.
- (5) The water processed by the ion exchange water softener accelerates the depletion of the Mg-Stick in the water tank. Therefore, you are advised not to connect the water inlet of the air source water heater to a water softener.



## 4.2 Basic Requirements for Installation Sites

The following sites for installing the air source water heater may be prone to become faulty. If the following sites cannot be avoided, please consult your local service centers authorized by NORDCEL to customize special models.

- (1) Environments that are exposed to strong heat sources, steam, flammable gases, or volatile substances.
- (2) Places where there are high-frequency facilities, such as welding machines or medical equipment.
- (3) Seaside saline areas.
- (4) Places where the air contains oil (such as machine oil).
- (5) Places where the air contains sulfide gases (such as sulfide hot springs).
- (6) Other special environments.

## 5 Main Unit Installation

### 5.1 Location for Installing the Main Unit

The main unit must be installed at a location where:

- (1) The noise and air flow generated by the air outlet do not affect neighbors, animals, and plants.
- (2) Good ventilation of the main unit can be ensured, and there are no obstructions nearby that hinders the air intake or output of the unit.
- (3) The installation position is able to withstand the weight and vibration of the main unit, and the installation can be safely performed.
- (4) The place is dry and not exposed to direct sunlight or strong winds.
- (5) The installation dimension diagram of the main unit can be complied with, and it is convenient to maintain and check the unit.
- (6) The main unit is out of the reach of children.
- (7) It does not hinder public aisle or affect city appearance.

### 5.2 Space Requirement for Main Unit Installation

- (1) The installation requirements of the water heater's main unit are the same as those of the outdoor unit of an air conditioner. The main unit can be installed in the exterior walls, roof, balcony, or ground. The air

outlet should avoid the wind direction. The dimension diagram of the main unit structure is shown in Figure 5-1 (unit: mm).

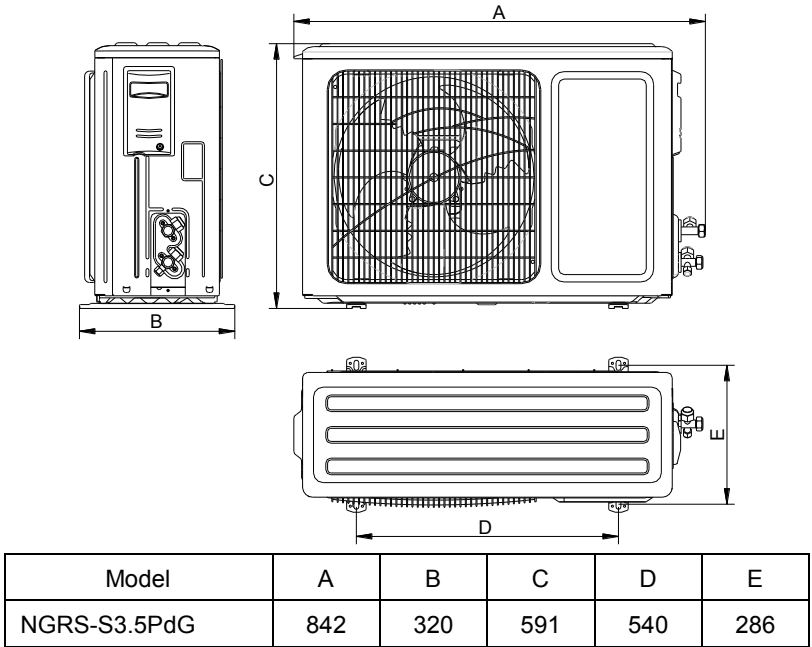

Figure 5-1 Dimension diagram of the main unit structure

(2) The distance between the main unit and the walls or other obstructions must not be too small, and the space for installing the main units must meet the requirements provided in Figure 5-2.

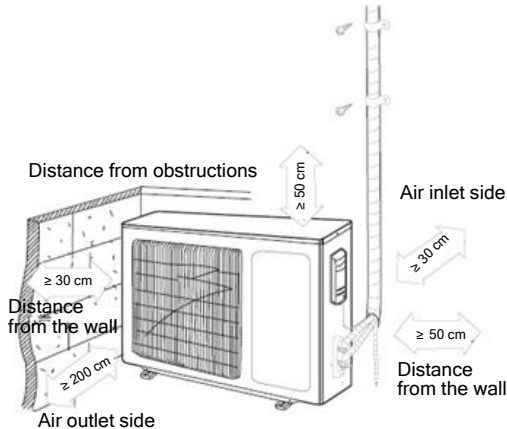

Figure 5-2 Space requirements for installation

- (3) If a canopy is to be installed for the water heater main unit, note that the heat dissipation and absorption should not be affected.
- (4) The main unit must be installed in the host places a solid foundation, and ensure that the main unit is installed upright, and fastened with foundation bolts. If the vibration is strong, add rubber gaskets to prevent vibration.
- (5) Condensate drain of the outdoor unit: buckle snap the drainage joint of the outdoor unit into the drainage hole located in the middle of the chassis, as shown in Figure 5-3, and ensure reliable and tight fitting. Then, connect the drainage pipe to the drainage mouth, and guide the drainage pipe to a proper place for drain.

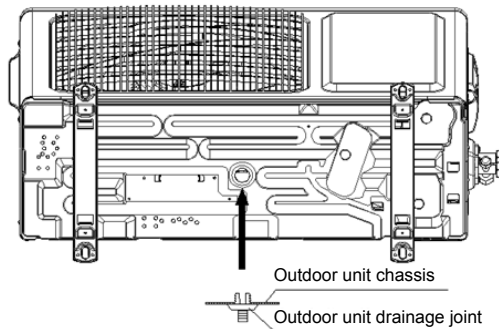

Figure 5-3 Drainage pipe connection

## 6 Installation of the Water Tank

- (1) The water tank can be installed outdoors with the main unit, for example, installed in the balcony, roof, or ground. It can also be installed inside the room. Try to install it in an environment where the temperature is higher than 0°C. The hot water outlet should not be too far away from the locations for use. Lay out the pipes in a centralized manner, and take thermal insulation measures on hot water piping to reduce heat loss.
- (2) The water tank must be placed upright with all feet touching the ground. It must be installed on a solid foundation. During water tank installation, consider the weight bearing capability of the foundation. Figure 6-1 shows the installation diagram.

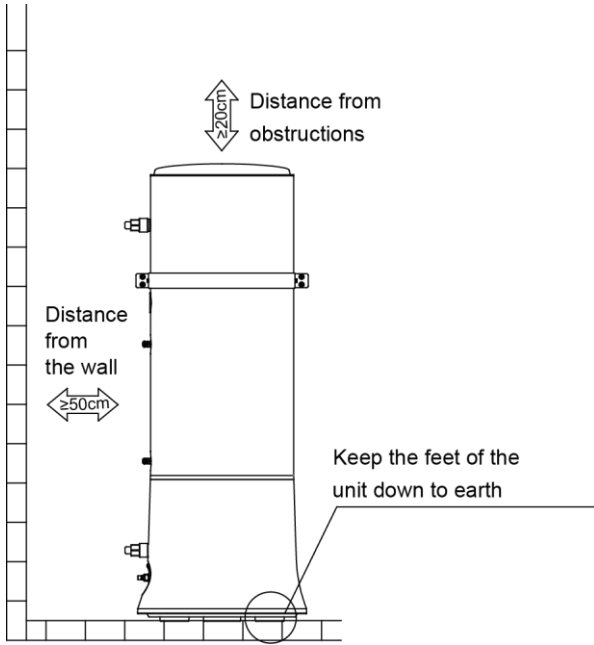

Figure 6-1 Fastness of the water tank

Note: The water tank must also be fastened to the wall using a tank mounting hoop or plate to prevent fall-off the water tank due to exceptions.

- (3) There should be water pipes, hot water interfaces, and floor drains to facilitate water replenishment for the water tank, hot water supply, and drainage. And the pressure of the tap water shouldn't higher than 0.7MPa, else, a decompressor should be installed in the water inlet pipe.

## 7 Pipeline Connection

### 7.1 Refrigerant Pipe Connection

- (1) If the water tank and the main unit need to be connected by punching through a wall, a hole of  $\Phi 55$  mm must be drilled in the wall and the hole should be inclined toward the exterior wall, as shown in Figure 7-1. Protective sleeves need to be put on both sides of the hole.
- (2) Bind up the connecting pipes, power cable, water temperature sensing package, and communication lines (if necessary) of the wired controller with thermal insulation bands, and then lead them through the hole.

- (3) Remove the refrigerant pipe joint from the water tank and the sealing nuts from the small and large valves of the outdoor unit, and add refrigerant oil on the joint and valve cones.
- (4) Remove the sealing caps of the connecting pipe. Align the center of the bell mouth with the pipe joint and valve cone, and screw up the conical nut with your hand and then with a wrench, as shown in Figure 7-2.

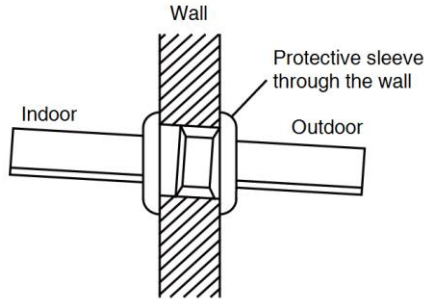

Figure 7-1 Refrigerant connecting pipe through the wall

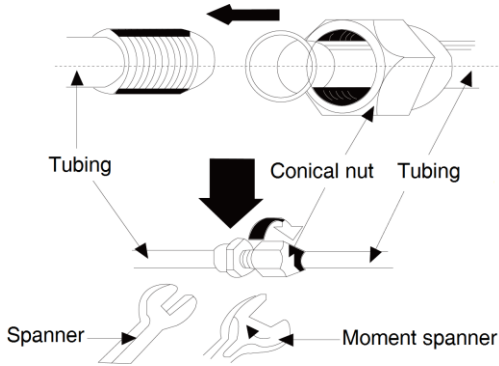

Figure 7-2 Fastening the connecting pipe



**NOTICE!**

Perform pipe layout and bending carefully. Do not damage connecting pipes. Do not screw up the nut too tight to damage to the nut, its corners, or the bell mouth, or too loose to cause leakage. Table 7-1 shows the tightening torque.

Table 7-1 Recommended tightening torque

Hex nut	Φ 6	Φ 9.52
Tightening torque (N•m)	15-20	31-35

## 7.2 Exhaust Methods

Table 7-2 Exhaust methods

Length of Connection Pipe	Air Exhaust Method	Refrigerant Charge Volume
Not greater than 10 m	Use a refrigerant in the outdoor unit	/
10 to 20 m	Use a vacuum pump	+22g/m

Note: The unit capability and energy efficiency decreases when length of the connecting pipe increases. Therefore, take thermal insulation measures on the connecting pipe when it needs to be extended.

(1) Use a refrigerant in the outdoor unit

- 1) Remove the valve cap and the fluoride injection mouth nut from the fluid valve and the air valve.
- 2) Use a hex key to slightly unscrew the valve plug of the fluid valve, and use a screwdriver to jack up the valve core of the air valve. Then, the air is discharging.
- 3) Discharge the air for about 15 seconds. When there is refrigerant gas discharged, close the valve core and tighten the fluoride injection mouth nut.
- 4) Fully open the valve cores of the fluid valve, and the air valve, as shown in Figure 7-3.
- 5) Tighten the valve cap, and then use a leak detector or soapy water to check whether the pipes for connecting the outdoor unit and the water tank leak.

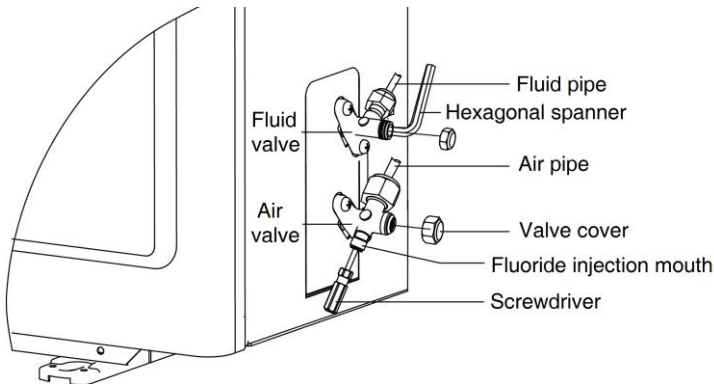

Figure 7-3 Opening the fluid valve and air valve

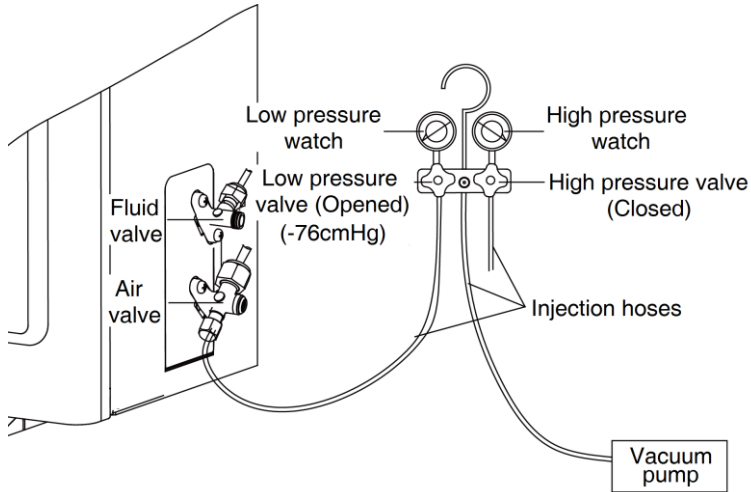

Figure 7-4 Vacuum pump connection diagram

(2) Vacuum pump

- 1) Connect the filling hose to the fluoride injection mouth of the air valve. Ensure that the valve cores of the air valve and fluid valve are tightly closed.
- 2) Connect the joint of the filling hose to the vacuum pump, as shown in Figure 7-4.
- 3) Fully open the low pressure valve of the pressure gauge.
- 4) Start the vacuum pump to vacuumize the air for 20 minutes or more, and ensure that the pressure gauge pointer points to  $-1.0 \times 10^5$  Pa (-76cmHg). Close the low pressure valve, and stop the vacuum pump. Wait 2 minutes. If the number indicated by the pressure gauge pointer does not rise, the vacuumization and piping are successful. If the number indicated by the pressure gauge pointer rises, it indicates that air is entering the system. In this case, check the piping for leaks, and vacuumize the air again.
- 5) Remove the filling pose from the air valve.
- 6) Fully open valve cores of the gas valve and fluid valve.
- 7) Tighten the valve caps of the air valve and fluid valve, and the fluoride injection mouth nut.

- 8) Tighten the valve caps, and then use a leak detector or soapy water to check whether the pipes for connecting the outdoor unit and the water tank leak.

## 7.3 Water Pipe Connection

### (1) Pipe preparation

The hot water outlet shall select hot water pipe, PPR pipe is recommended, with fast heat dissipation, e.g. aluminum plastic tube is not suggested.

### (2) Water inlet and outlet pipe installation

Water inlet pipe shall install safety valve, filter and cut off valve, installation sequence shall accord with unit installation diagram. Water outlet pipe shall have at least one cut off valve.

To drain or clean the water tank, add a 3-way and a cut off valve in water outlet of water tank; If the water tank is far away from user water use site (hot water pipe is  $>20\text{m}$ ), or water use site of all hot water is lower than water inlet of the water tank, installation is needed.

### (3) Drainage pipe installation

As Figure 8-1 is shown, add a 3-way valve in cold water inlet pipe, then connect the 3-way connector and floor drain with pipeline, meanwhile the connection side of drainage pipeline and floor drain shall be lower than water tank bottom, otherwise, water cannot be discharged completely. A cut off valve must be installed in drainage pipeline, and the cut off valve must be installed in places where the user is accessible.

### (4) Safety valve installation

The safety valve (“→” indicates the direction to the water tank) supplied with the unit shall be connected to the inlet of the water tank via a stub of PPR as Figure 7-5 is shown. The other end of the safety valve is connected with running water pipe. To ensure usage safety, sequence in Figure 8-1 shall be strictly obeyed.

Cut off valve or check valve (one-way valve) shall not be installed between safety valve and the water tank, otherwise, safety valve shall not work normally, water tank error might occur.

During heating operation process, safety valve dripping water is a normal phenomenon of pressure relief. Under standby status, if the safety valve keeps



dripping water, please check if water pressure is too high (not over 0.7MPa). If water pressure is higher than 0.7MPa, install stabilizing valve correctly according to “(6) Stabilizing valve installation”; if water pressure is below 0.7MPa, please check and replace safety valve.

Safety valve must install diversion tube and be reliably fixed to prevent falling off; lead the drainage hose to floor drain downward naturally and properly without bending or any twine. After that, the surplus hose must be cut to avoid water in drainage hose getting frozen due to blocking of drainage or low temperature.

To avoid any inconveniences or property losses due to water leakage or safety valve discharging water which is resulted from improper connection of water pipe, water tank and safety valve shall not be installed inside the room or balcony which is without discharge floor drain.

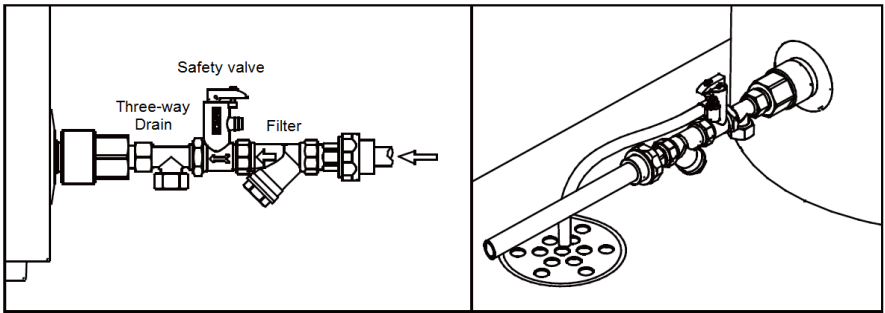

(a) Installation method 1

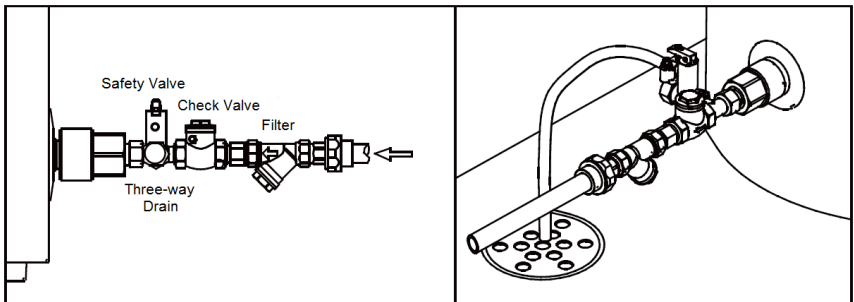

(b) Installation method 2

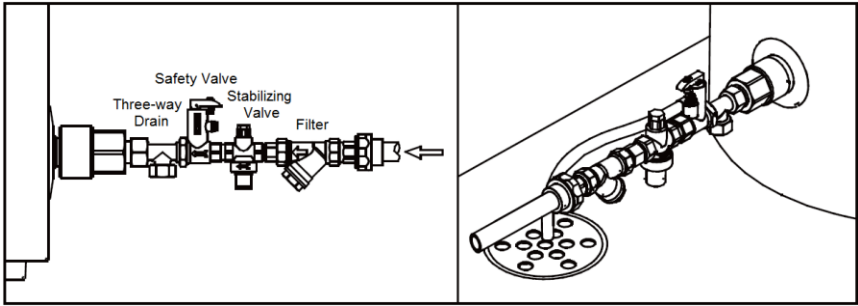

(c) Installation method 3

Figure 7-5 Safety valve installation diagram of water inlet pipe in water tank

Material code	Name	Specification	pressure	Quantity
07382801	Safety valve	G1/2	0.7Mpa	1

(5) Antifreezing tracing belt installation

If the water tank shall inevitably be installed in places with temperature below 0°C, to avoid the pipeline getting frozen due to bad insulation of water system pipeline, antifreezing tracing belt for pipeline shall be installed in water inlet pipe of water tank, our pipeline antifreezing tracing belt and its accessories is recommended, d etailed list is as follows:

Material code	Name	Quantity
76612816	Selflimiting temperature tracing belt	1
01802894	frame	1
8600800101	aluminum-foil paper	1
64132820	Pipeline antifreezing tracing belt installation statement sheet	1

(6) Stabilizing valve installation

Before connecting water pipe, measure water supply pressure of running water first, if water pressure is over 0.7MPa, add stabilizing valve in waterway, otherwise, pressure relief on safety valve might occur when the unit is not heated. Stabilizing valve (“→” direction shall accord with the water tank direction) shall be installed between safety valve and filter.



**NOTICE!**

- ① To ensure water safety, the PPR pipe length at the water inlet and outlet is determined as per the formula:  $L \geq 70 \times R^2$ , wherein L indicate the pipe

length, and R indicates the inner diameter of the pipe (unit: cm). The pipe should be insulated properly. No metal pipe is allowed.

- ② To ensure safety and reliability, special accessory equipped with this unit must be adopted (PPR water pipe joint, safety valve and filter etc.). Don't use the accessory of any third party and replace the accessory by yourself, any losses thereof for normal operation and usage of heat pump water heater result from personal injury and improper installation, NORDCEL shall not be liable.

## 8 Installation Diagram of the Unit

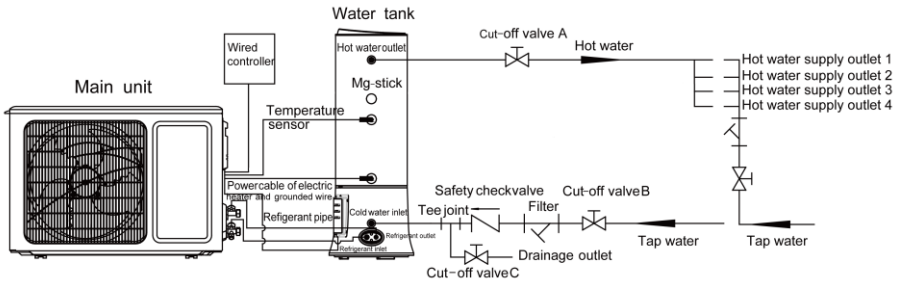

Figure 8-1 Installation diagram of the unit

Table 8-1 Dimensions and specifications

Name	Interfacing Pipe Screw Thread
Hot water outlet of the water tank	G1/2
Cold water inlet of the water tank	G1/2



**NOTICE!**

- (1) Prepare materials according to the preceding dimensions and specifications. If the cut-off valve is installed outdoors, PPR pipes are recommended to prevent freezing caused by low temperature.
- (2) Install the piping system only after the unit is fastened. Prevent dust and other foreign matters from entering the piping system during pipe connection or installation.
- (3) After all pipes required are installed, check leakage first, and then take thermal insulation measures on the waterway system. Particularly, note the following:  
Take thermal insulation measures on the valves and pip joints. A thickness of not less than 15 mm is recommended for the thermal insulation cotton.
- (4) The thermal insulation and pressure-bearing water tank can supply hot water only when the tap water is available.
- (5) When using hot water, ensure that cut-off valve of the cold water inlet of the water tank is open.

## 9 Wiring

### 9.1 Wire Layout

- (1) This air source water heater is class I appliance. Ensure that wire layout is performed by professional personnel according to national wiring rules.
- (2) Ensure that a switch for all-pole disconnection is available for the fixed lines and is directly connected to wiring terminals of the power supply. Ensure that contactor opening distance on all poles meets the disconnection requirements under overvoltage category III conditions.
- (3) Ensure that reliable grounding measures are taken. A dedicated grounding apparatus should be used.
- (4) Use the power supply with specifications provided in the nameplate, and use circuits dedicated for air conditioners.

- (5) Copper-conductor cables must be adopted for power cables, and the operating temperature should not greater than the stipulated value. The diameter of the cables should be large enough. For details, refer to Table 9-1. If the length of the power cable is greater than 15 meters, choose a power cable with a larger cross-sectional area to prevent problems caused overloading. Do not pull the power cable during the installation.
- (6) If the installation conditions on site change, consider using cables whose reduced capacity can still meet site requirements, based on the specifications of the power cables and air circuit breakers provided by the vendor.
- (7) If the supply cord is damaged, it must be replaced by the manufacturer, its service agent or similarly qualified persons in order to avoid a hazard.

Table 9-1 Power configuration table

Model	Power Supply	Minimum Sectional Area (mm <sup>2</sup> ) of Power Cables			Air Circuit Breaker Capacity (A)
		Firing Line	Zero Line	Ground Line	
NGRS-S3.5PdG	220-240V ~50Hz	1.5	1.5	1.5	16

## 9.2 Wire Connections

- (1) Unscrew the screw on the connection box cover on the right side panel of the main unit to open the connection box cover. Figure 9-1 shows the external wiring.

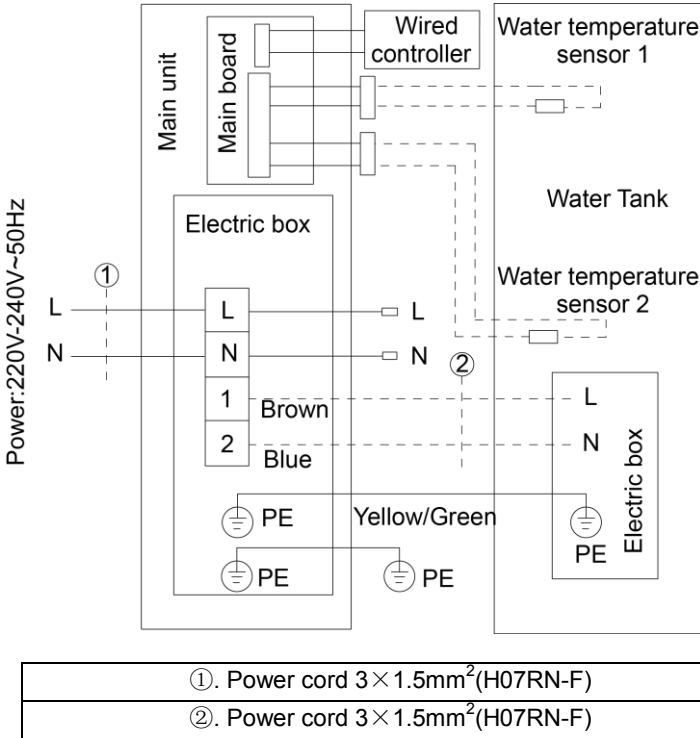

Figure 9-1 External wiring for NGRS-S3.5PdG mapping  
NSXD200LCJW

- (2) If the unit is equipped with a grounding cable, connect one end of the ground cable to the grounding screw of the water tank, and the other end to the grounding screw in the connection box on the right panel of the main unit.
- (3) Select an appropriate power cable (with a leakage circuit breaker) according to the power configuration table, and connect it to the main power supply.
- (4) Connect the interface of the temperature sensor delivered with the water tank to the interface coming from the connection box of the main unit according to the identifiers (“TOP” for “TOP” and “BOTTOM” for

“BOTTOM”) on the line of the temperature sensor. Put the temperature sensor inside the connection box. The line of the temperature sensor must be clamped tightly. Check whether the temperature sensor is securely fastened. The interface marked "CYCLE" coming from the main unit interconnects with the cycle temperature sensor only during installation of a water return system.

- (5) Use wire clips to clamp the strong wires, and install the connection box to the original place.
- (6) Fasten the wired controller, and connect it to with the communications line coming from the main unit.
- (7) The communications line of the wired controller and the line of the temperature sensor should be separated from the power cable, and the distance between them should be greater than 20 cm. Otherwise, the unit may not be able to communicate properly. Strong wires and weak wires need to be separately sheathed.

## 10 Wired Controller Installation

### 10.1 Requirements for Wired Controller Installation Locations

- (1) Do not install the wired controller in a wet place or a place exposed to direct sunlight.
- (2) Do not install the unit or wired controlled of the air source water heater in a place susceptible to electromagnetic interference.
- (3) Ensure that the communications line is connected to the correct interface. Otherwise, communication will be failure.

## 10.2 Wired Controller Installation

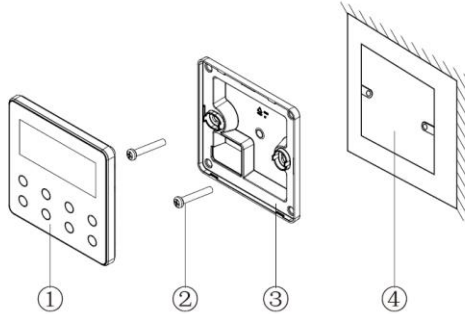

No.	1	2	3	4
Name	Front panel of wired controller	Screw	Soleplate of controller	Socket's base box installed in the wall

Fig 10-1 Accessories of Wired Controller

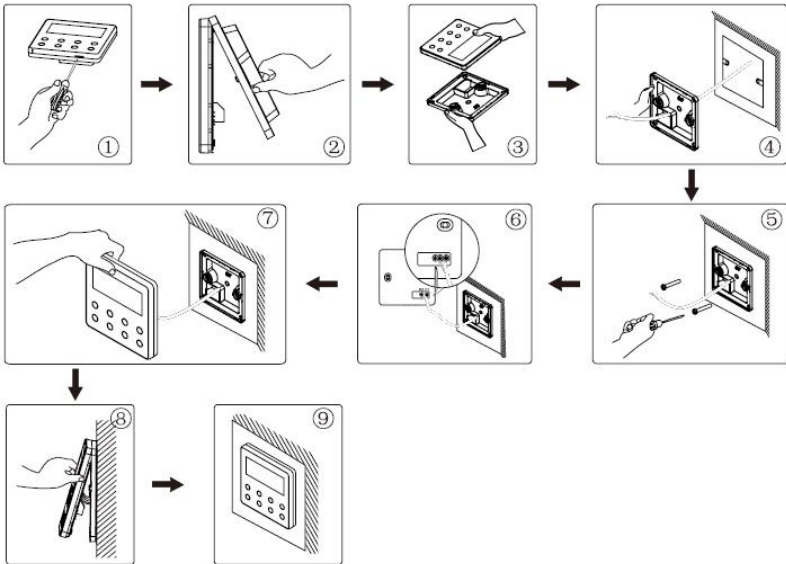

Figure 10-2 Installation Diagram of Wired Controller

Figure 10-2 is the installation diagram of wired controller. Cut off power supply of heavy-current wire embedded in mounting hole in the wall before installation. The installation method is as below:

Pry the removal port with straight screwdriver to separate the front panel and soleplate of wired controller;



Pull out the communication cable (4-core twisted pair wire) in the base box and then make the communication cable go through the hole of soleplate of wired controller;

Joint the controller's soleplate and base box with screws M4×25;

Insert the communication cable (4-core twisted pair wire) into controller's slot;

Buckle the front panel and soleplate of controller together.



**NOTICE!**

During the following connections, pay special attentions to prevent malfunction due to electromagnetic interference:

- (1) The communications line of the wired controller and the line of the temperature sensor should be separated from the power cable, and the distance between them should be greater than 20 cm. Otherwise, the unit may not be able to communicate properly.
- (2) If the unit is installed in a place susceptible to electromagnetic interference, the communications line of the wired controller and the line of the temperature sensor must be used, shielded twisted pair.

## 10.3 Rainproof Box Installation

If the wired controller is to be installed in outdoors or dank places, please install a rainproof box for wired controller. Pay attention to cut off the power supply of heavy current wire embedded in the installation hole of wall. The whole installation procedure shall be done without electricity. The installation method is as follows:

Separate the panel of wired control and bottom plate with a flat screwdriver;

Pull out the communication wire (4-core twisted pair wire) inside the installation box and make this wire go through the wire-crossing hole of rainproof box and wired controller bottom plate;

Secure the bottom plate of wired controller, rubber cushion, rainproof box at the installation box with screws; if there is no installation box in the wall, please drill hole on the wall and install plastic expansion pipe. Secure the bottom plate of wired controller, rubber cushion and rainproof box at the plastic expansion pipe with tapping screws (plastic expansion pipe and tapping screw are provided by

our company);

Insert the communication cable (4-core twisted pair wire) into the groove of wired controller;

Align the panel of wired controller with the bottom plate and then fasten them together.

Note: When disassembling the wired controller, please use the flat screwdriver carefully (As shown in Figure 10-4).

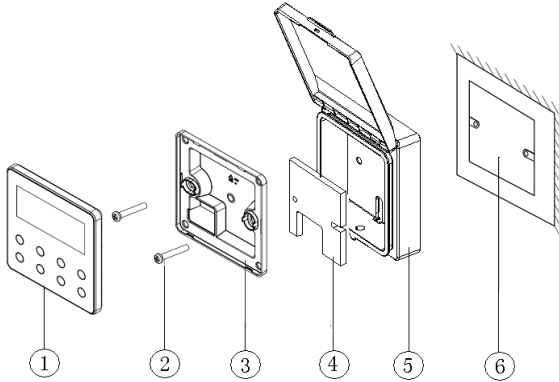

No.	Name	No.	Name
1	Panel of wired controller	4	Rubber cushion(rainproof box)
2	Screw	5	Rainproof box
3	Bottom plate of wired controller	6	Installation box inside the wall

Figure 10-3 Rainproof Box Assy of Wired Controller

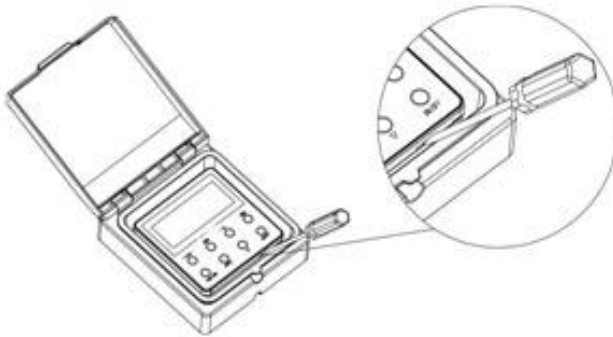

Figure 10-4 Disassembly Diagram of Rainproof Box of Wired Controller

# 11 Commissioning

After installing the main unit, water tank, wired controller, waterway system, fluorine circulation system, and electrical wiring, check the unit based on the following checklist.

Table 11-1 Checklist for the installation

<b>Check Item</b>	<b>Possible Symptoms Caused by Improper Installation</b>
Are the main unit and water tank securely fastened?	The main unit and the water tank may fall, or vibration or noise may be caused.
Are there any obstructions to the air outlet and inlet of the main unit?	The unit does not work properly.
Is the connection pipe of the water tank properly insulated?	Potential hazards may exist.
Are thermal insulation measures taken on the waterway pipes?	The performance of the unit may be affected or the pipes may be frozen and damaged.
Is the power voltage consistent with the voltage indicated in the nameplate?	The unit may become faulty or the parts may be burnt.
Does the wire model comply with specifications?	The unit may become faulty or the parts may be burnt.
Is a safety check valve installed for the water inlet pipe?	If the water tank bears high pressure, safety hazards exist. The water may be returned if water supply stops.
Is the tap water replenishment pressure too high?	If the water tank bears high pressure, the safety check valve discharges water and abnormal noise is caused.
Is a pressure reduction valve installed for the water inlet pipe when the water replenishment pressure is too high?	If the water tank bears high pressure, the safety check valve discharges water and abnormal noise is caused.
Is the ground wire of the water tank reliable?	Potential hazards may exist.
Is the temperature sensor securely connected?	Performance of the water tank is affected.
Is the temperature sensor inserted to the bottom of the water tank?	The water temperature displayed in the wired controller is different from the actual temperature. The unit is protected from high pressure.

Perform the following commissioning steps only after all the preceding check items are passed:

(1) Water replenishment

Follow the instructions in section 16.1 or the installation notes on the water tank to replenish water for the tank water tank, and check whether the pipes or joints for leaks. For initial installation, this step must be performed by installation and commissioning personnel. If a drain operation is performed before use of the unit, replenish water before starting the unit.

(2) Power-on of the unit

After the unit is powered on, "beep" can be heard from the wired controller buzzer. Observe whether the wired controller is displayed properly. If there is no fault code, the unit is normal. The wired controller has a power memory function. However, if the wired controller is power on for the first time, it may indicate power-on, power-off, or standby. **Note that the unit can be powered on only after the water tank full filled with water, and do not power on the unit before the water replenishment.**

(3) Wired controller parameter settings

System clock time setting, disinfection function setting, etc.

(4) System operating

After the water tank is full filled with water, check the waterway system to ensure that the tap or sprayer is closed and cut-off valves of the inlet and outlet pipes of the water tank are open before starting the unit. When the heating icon is displayed on the wired controller, check whether the unit runs properly. The unit runs properly if the following criteria are met: The fan runs properly; the unit runs smoothly without shaking or abnormal sound. Hand over the unit to the user after the unit runs properly at least for 20 minutes.

## 12 Methods for Replenishing or Discharging Refrigerants

### 12.1 Refrigerant Replenishment

Refrigerants can be replenished for the source water heater only in specific mode.

First, connect the hose in the middle of the pressure gauge to the refrigerant bottle, and connect (but do not tighten) one end of the blue hose of the low

pressure gauge to the fluoride injection mouth of the air valve on the unit. Then, open the valve of the refrigerant bottle. Open the valve next to the low pressure gauge for 5 seconds and close it, and immediately tighten the hose interface on the fluoride injection mouth.

In normal hot water mode, press and hold MODE+▲ for 5 seconds to enter the query status. When the temperature display area displays 00, press and hold MODE+▲ for 5 seconds. Then, 00 changes to P0. Press the ▲ or ▼ button to switch to the P3. Then, press the MODE button for settings. Press the ▲ or ▼ button again to change 00 in the time display area to 01. Press MODE to confirm and complete the settings. After the settings are complete, when the low pressure gauge pointer declines, you can loosen the valve next to the low pressure gauge for refrigerant replenishment (Figure 12-1 shows the diagram for refrigerant replenishment).

## 12.2 Refrigerant Discharging

Open the air valve using a hex key to discharge the refrigerant (Figure 12-2 shows the refrigerant discharging diagram).



### NOTICE!

This operation can be performed only by professional personnel to avoid hazards. Inject refrigerants based on the nominal amount indicated on the nameplate when charging refrigerants.

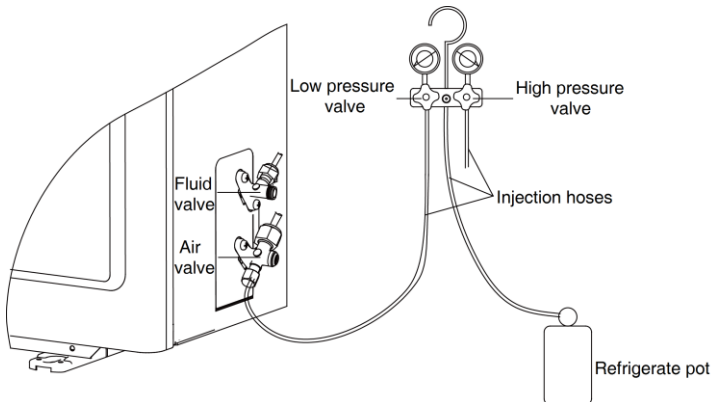

Figure 12-1 Refrigerant replenishment diagram

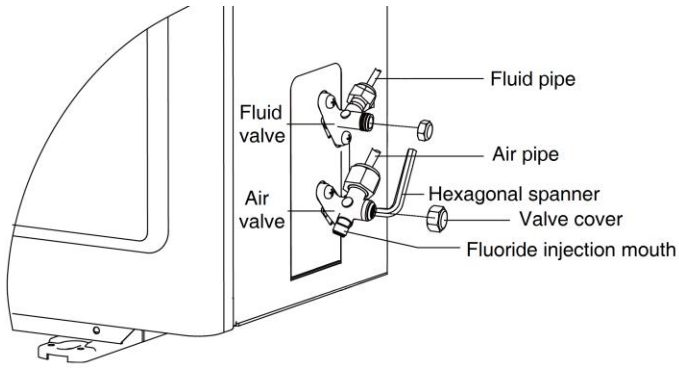

Figure 12-2 Refrigerant discharging diagram

## 13 Method for Refrigerant Reclamation

Refrigerants can be reclaimed for the source water heater only in specific mode.

In normal hot water mode, press and hold MODE+▲ for 5 seconds to enter the query status. When the temperature display area displays 00, press and hold MODE+▲ for 5 seconds. Then, 00 changes to P0. Press the ▲ or ▼ button to switch to the P3. Then, press the MODE button for settings. Press the ▲ or ▼ button again to change 00 in the time display area to 01. Press MODE to enter the defrosting mode, and complete the settings for refrigerant reclamation settings. After the settings are complete, first close the fluid valve (smaller valve), and when there is cold air blowing out from the outlet, immediately close the air valve (larger valve). After it is closed, immediately shut down the unit.



### NOTICE!

Refrigerant reclamation must be promptly completed, so as not to cause any damage to the unit. If refrigerant reclamation is required, please contact the professional personnel to perform refrigerant reclamation.

## 14 Performance of the Unit

### 14.1 Heating Capacity

During heating, the unit will absorb the heat from outdoor air constantly and then release the heat to water for heating the water inside the water tank. Once the outdoor temperature is decreased, the heating capacity will also be decreased. Figure 14-1 and Figure 14-2 are the correction diagram of water generation capacity under different mode and the COP curve diagram with the change of ambient temperature (only for reference).

The unit's water generation capacity will increase with the increased of ambient temperature. Under the same ambient temperature, the maximum water generation capacity is under Rapid mode, and then the Hot water mode. The heating time under SE mode is longer. Under the normal circumstances, the required time for heating 200L water is 1-3 hours in summer, 2-5 hours in spring. The required time in winter is longer. Under Save mode, the time for heating 200L water will not longer than 7.5h (under -25 ambient temperature).

After pressing "Rapid" button on the wired controller, the heating speed will be increased, and then power consumption will also be increased. If selecting "SAVE" mode, the heating speed will be decreased, and the power consumption will also be decreased. The defaulted mode after ex-factory is Hot water mode.

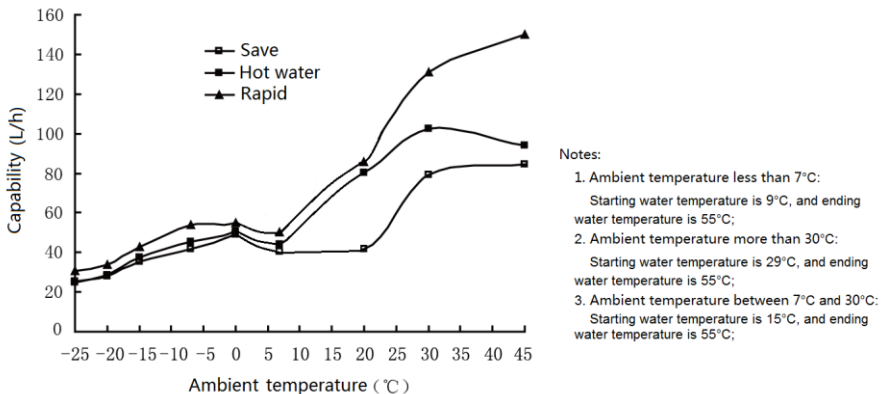

Figure 14-1 Correction diagram of capacity

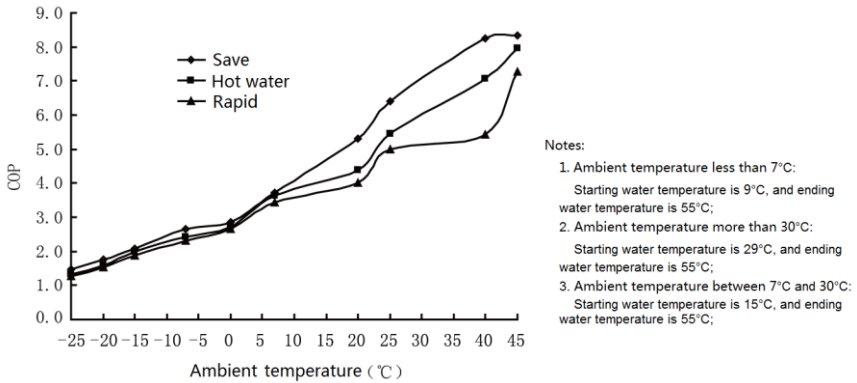

Figure 14-2 Correction diagram of COP

## 14.2 Operating Performance

### (1) Defrosting

- 1) If frosting appears during water heating, the unit automatically enables the defrosting function to improve the heating effect.
- 2) When defrosting runs, the unit stops running the fan;
- 3) If defrosting runs in high ambient temperatures (> 10 °C), the unit is running improperly. In this case, please report for repairing.

### (2) Starting the unit after long-time shutdown

If the unit is not used for a long time, turbid fluid may come out from the tap when the unit is started again (or started for the first time). This is a normal phenomenon. Wait a moment, the turbid fluid will disappear.

### (3) Power outage

- 1) If an outage occurs when the unit is running, all tasks are stopped.
- 2) The wired controller has a power memory function.
- 3) If a malfunction occurs due to lightning or car radio, manually cut off the power switch, and then power on the unit again.

### (4) Power memory function

Every time before the power of the water heater or wired controller is cut off, the wired controller automatically memorize the power switch status of the unit. After the power is restored, the wired controller sends power-on/power-off signals to the water heater according to the status memorized before the power is cut off. This ensures that the unit can run according to the original status after



the power is restored.

## 15 Operation Notices in winter

- (1) Before starting the unit which has not been used for a long period or in quite low temperature in winter, energize it at least 8h ahead.
- (2) Do not disconnect the power supply when the outdoor temperature is quite low in winter, otherwise the automatic antifreeze protection will fail to work. Under low ambient temperature, anti-freezing operation function of the unit will conduct heating for anti-freezing before water temperature of the water tank come near to freezing point, and it stops if water temperature of the water tank rises to safe temperature. But the auto anti-freezing operation function of the water tank is invalid for water inlet/outlet pipe of the water tank. If ambient temperature of unit installation location is below 0℃, pipeline anti-freezing tracing belt must be installed and ensure the aforementioned belt is energized. If the water tank is installed outdoor inevitably, shorten outdoor piping length as much as possible, including refrigerant connection pipe and water inlet pipe of the water tank, otherwise, heat dissipation loss of the unit is big, power consumptive and water system is easy to be frozen. Special attention shall be paid to thermal insulation blind spot on local valve connection location and water pipe curve, strengthen the thermal insulation, otherwise, local pipe will be frozen.
- (3) When the unit is not to be used for a long period, drain the water tank and pipe according to discharge operation, otherwise, water system will be damaged. After draining water and to reuse the unit again, pours water to the water tank fully before starting up. Please refer to water input and drainage operation of the water tank.

### **Warm hint:**

If it's not convenient for operation or there's hazard, please contact the local appointed dealer or appointed service center directly. We will appoint profession persons to check, debug and clean the unit, and discharge water and fill the water tank with water for you.

## 16 Maintenance

### 16.1 Water Input and Drainage of Water Tank

- (1) Operation process for water input on the water tank
  - 1) Cut off the power supply and open the cut-off valve at the water inlet of the tap faucet;
  - 2) Open the cut-off valve at the hot water drain outlet and valve in user water use site;
  - 3) Close the valve in user water use site when water is flowing out from user water use site;
  - 4) Complete water input operation and reenergize the unit.
- (2) Operation process for drainage on the water tank
  - 1) Cut off the power supply and close the cut-off valve at the water outlet of the tap faucet;
  - 2) Open the cut-off valve at the hot water drain outlet and valve in user water use site;
  - 3) Open the cut-off valve on the joint (3-way) pipe;
  - 4) Close the drainage cut-off valve after draining water on the water tank to complete drainage operation.

### 16.2 Periodic Cleaning for Water Tank

Please clean the water tank periodically to get good-quality water according to the following steps:

- (1) Cut off the power supply.
- (2) Close the cut-off valve at the water inlet of the water tank.
- (3) Open the cut-off valve at the hot water drain outlet and valve in user water use site.
- (4) Open the cut-off valve in joint (3-way) connector, and wait for drainage of water inside water tank.
- (5) Close the cut-off valve in joint (3-way) connector, open the cut-off valve at the water inlet of the water tank, close the cut-off valve at the water inlet when water flows from user water use site, then reopen the cut-off valve in joint (3-way) connector, repeat the drainage operation, close

the cut-off valve in joint (3-way) connector when water discharged is clean.

- (6) Conduct water input for the water tank according to water input operation.
- (7) Water tank cleaning completed and energize it.

## 16.3 Replacement of magnesium rod

As for ensuring the service life of water tank, magnesium rod is installed inside the water tank. In general, the service life for the magnesium rod is 2-3 years. If the water quality for the hot water is bad, the service life for the magnesium rod will be shortened. The process for replacing the magnesium rod is as below:

- (1) Drain out the water inside the water tank completely before disassembly;
- (2) Open the protection cover at the installation outlet of the magnesium rod of water tank;
- (3) Twist off the magnesium rod with inner hexagon, and then take it out carefully to prevent sillage of magnesium rod dropping into the inner pot of water tank;
- (4) Install the new magnesium rod and then fix it with inner hexagon wrench;
- (5) Close the protection cover and then fill the water tank with water according to water supply operation.

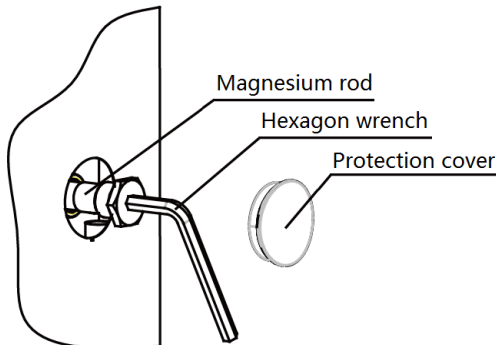

Figure 9-1 Sketch map for the replacement operation for the magnesium rod



**NOTICE!**

The replacement for the magnesium rod must be conducted by the professional person. Do not replace it by yourself. Please contact NORDCEL appointed local dealer or appointed service center.

## 16.4 Safety Valve Maintenance

In the heating process, when the inner container of water tank is in overpressure, a small amount of water may be discharged through the safety valve, which is a normal phenomenon. However, if a large amount of water is discharged through the safety valve or even pipe vibration occurs and abnormal noise is caused, contact NORDCEL authorized maintenance centers. The possible causes of this problem are as follows: The safety valve is damaged; the water replenishment pressure is higher than the maximum working pressure (0.7MPa) of the water tank, which occurs generally when pressure reduction is not performed on the tap water. In normal conditions, the tap water pressure is around 0.3 MPa. If a booster pump is used to replenish water, the water replenishment pressure may exceed 0.7 MPa. In this case, a pressure reduction valve needs to be added to the tap water replenishment pipe to reduce water replenishment pressure.

Open the safety valve's handle to check whether it is blocked on a regular (about once a month) basis. If it is blocked, contact the authorized maintenance center for check or replacement. Perform sewage disposal by following the guide on a regular (about once a year) basis.

## 16.5 Maintenance of the Unit

- (1) Check the water inlet and outlet for blockage periodically. If so, eliminate it.
- (2) Check the water circuits, pipe connectors and valves for blockage, damage or leakage, and if the filter has been blocked by impurities.

## 17 Precautions for Safety Usage

- (1) For comfort usage, it's suggested to use shower head with flow rate of 6~7L/min.
- (2) User should have regular check and maintenance for heat pump water heater, if there is abnormal condition, please immediately contact to NORDCEL after-sales service for help so as to guarantee normal, safe and reliable unit operation.
- (3) Regular check and replace the magnesium bar is necessary. Customer can contact NORDCEL serviceman for replacement. Recommended replace period is 2~3 years.
- (4) Cut off the power supply prior to any maintenance or services. A unprofessional personnel is not allowed to adjust or service the heat pump water heater.
- (5) Improper operation might cause scald due to hot water. Water heating without enough water might produce high-temperature steam or hot water, which might cause serious scald. Hence, guarantee the water tank is filled with water.
- (6) The water heater is equipped with safe relief valve for reliable operation, please don't change its location and never block its outlet. The pipe should be directly connected to floor drain.
- (7) Never drink the water inside the water tank.
- (8) Children bath should be supervised by adults.
- (9) This appliance can be used by children aged from 8 years and above and persons with reduced physical, sensory or mental capabilities or lack of experience and knowledge if they have been given supervision or instruction concerning use of the appliance in a safe way and understand the hazards involved. Children shall not play with the appliance. Cleaning and user maintenance shall not be made by children without supervision.
- (10) In order to prevent the hazard due to the invalidation if electric heating of water tank, the electric heating circuit is equipped with thermostat. If the water temperature is higher than 95°C, the thermostat will be activated to cut off the electric heating power. However, if the electric

heating is abnormal, it needs to contact NORDCEL service man to maintain or replace it.

- (11) The water inlet pressure for the water tank is 0.1MPa~0.7MPa. Before installation, please confirm the water pressure range. And the hose-sets should not be reused.

## 18 Malfunction Analysis



### WARNING!

Do not repair the unit by yourself, otherwise it would lead to electric shocks or fire hazards. Instead, please contact the NORDCEL appointed service center and it is better to check the items listed in the table below at first.

Table 18-1

Malfunction phenomena	Troubleshooting
The unit won't operate immediately once immediate re-startup of the unit after stop.	In order to protect the unit, the control of the unit will delay the turn-on command for five minutes.
There is water flowing sound during operation of the unit.	During operation of unit, there will be swoosh or fizzle, which is flowing sound of refrigerant and is normal.
There is condensate drained from main unit.	It is normal. Do not worry about it. Please refer to Chapter 3.6, connect to suitable discharge location with discharge pipe.
There is water drained from safety valve.	During heating, if pressure of inner tank of the water tank is too high, it will discharge little water to release pressure through safety valve, which is a normal phenomenon. However, if water of big outflow occur in safety valve obviously, even result in vibration of pipeline and give out abnormal noise, please contact with our authorized maintenance center for inspection.
The controller tells that the unit is under antifreeze protection	The unit will automatically activate the antifreeze function in winter, which is normal.
The nozzle provides water flow for quite a short period.	It is because the nozzle is oversized. Please replace it. The nozzle with the flow rate of 6~7L/min is preferred.
Wired controller displays L6 and water temperature alternately	Ambient temperature is too bad, which exceeds operation range of main unit.

Table 18-2

 Please contact the NORDCEL appointed service center in case of any of following conditions.	
Malfunction phenomenon	Malfunction analysis
The water heater stops operation and the wired controller displays E1	High pressure protection
The water heater stops operation and the wired controller displays E3	Refrigerant-lacking protection
The water heater stops operation and the wired controller displays C5	Malfunction of jumper cap
The water heater stops operation and the wired controller displays E4	Discharge protection
The water heater stops operation and the wired controller displays E5	Overload protection of compressor
The water heater stops operation and the wired controller displays E6	Communication malfunction
The water heater stops operation and the wired controller displays F3	Malfunction of outdoor ambient temperature sensor
The water heater stops operation and the wired controller displays F4	Malfunction of discharge temperature sensor
The water heater stops operation and the wired controller displays F6	Malfunction of tube temperature sensor for outdoor heat exchanger
The water heater stops operation and the wired controller displays Fd	Malfunction of suction temperature sensor
The water heater stops operation and the wired controller displays FE	Malfunction of upper temperature sensor of water tank
The water heater stops operation and the wired controller displays FL	Malfunction of lower temperature sensor of water tank
The water heater stops operation and the wired controller displays L6	Unit's capacity is insufficient
The water heater stops operation and the wired controller displays PL	Low voltage protection for drive DC bus bar of inverter compressor or voltage dropping malfunction
The water heater stops operation and the wired controller displays PH	High voltage protection for drive DC bus bar of inverter compressor
The water heater stops operation and the wired controller displays PA	Drive DC current protection of inverter compressor (input side)
The water heater stops operation and the wired controller displays H5	Drive IPM module protection of inverter compressor
The water heater stops operation and the wired controller displays HC	Drive PFC protection of inverter compressor



Please contact the NORDCEL appointed service center in case of any of following conditions.

Malfunction phenomenon	Malfunction analysis
The water heater stops operation and the wired controller displays Lc	Failure startup of inverter compressor
The water heater stops operation and the wired controller displays Ld	Phase-lacking protection of inverter compressor
The water heater stops operation and the wired controller displays P0	Drive module reset of inverter compressor
The water heater stops operation and the wired controller displays P5	Overcurrent protection of inverter compressor
The water heater stops operation and the wired controller displays LF	Power protection of inverter compressor
The water heater stops operation and the wired controller displays Pc	Detection circuit malfunction of driven circuit of inverter compressor
The water heater stops operation and the wired controller displays H7	Desynchronizing protection of inverter compressor
The water heater stops operation and the wired controller displays P6	Drive communication malfunction between main control and inverter compressor
The water heater stops operation and the wired controller displays P8	High temperature protection of drive module of inverter compressor
The water heater stops operation and the wired controller displays P7	Malfunction of temperature sensor of drive module of inverter compressor
The water heater stops operation and the wired controller displays ee	Malfunction of drive storage chip of inverter compressor
The water heater stops operation and the wired controller displays PU	Malfunction of drive charging loop of inverter compressor
The water heater stops operation and the wired controller displays PP	Abnormal protection of drive DC input voltage of inverter compressor
The water heater stops operation and the wired controller displays PF	Malfunction of temperature sensor of drive electric box of inverter compressor
The water heater stops operation and the wired controller displays P9	Zero-crossing protection of drive AC input of inverter compressor
The water heater stops operation and the wired controller displays AL	Low voltage protection of drive DC bus bar of inverter outdoor unit or voltage dropping malfunction
The water heater stops operation and the wired controller displays AH	High voltage protection of drive DC bus bar of inverter outdoor unit
The water heater stops operation and the wired controller displays AA	AC current protection of inverter outdoor fan (input side)





Please contact the NORDCEL appointed service center in case of any of following conditions.

Malfunction phenomenon	Malfunction analysis
The water heater stops operation and the wired controller displays A1	Drive IPM module protection of inverter outdoor fan
The water heater stops operation and the wired controller displays AF	Drive PFC protection of inverter outdoor fan
The water heater stops operation and the wired controller displays AC	Failure startup of inverter outdoor fan
The water heater stops operation and the wired controller displays Ad	Phase-lacking protection of inverter outdoor fan
The water heater stops operation and the wired controller displays A0	Drive module reset of inverter outdoor fan
The water heater stops operation and the wired controller displays A0	Overcurrent protection of inverter outdoor fan
The water heater stops operation and the wired controller displays UP	Power protection of inverter fan
The water heater stops operation and the wired controller displays AE	Detection circuit malfunction of driven current of inverter outdoor fan
The water heater stops operation and the wired controller displays AJ	Desynchronizing protection of inverter outdoor fan
The water heater stops operation and the wired controller displays A6	Driven communication malfunction between main control and inverter outdoor fan
The water heater stops operation and the wired controller displays A8	High temperature protection of driven module of inverter outdoor fan
The water heater stops operation and the wired controller displays A9	Malfunction of temperature sensor of driven module of inverter outdoor fan
The water heater stops operation and the wired controller displays An	Malfunction of drive storage chip of inverter outdoor fan
The water heater stops operation and the wired controller displays AU	Drive charting loop malfunction of inverter outdoor fan
The water heater stops operation and the wired controller displays AP	Abnormal protection of driven AC input of inverter outdoor fan
The water heater stops operation and the wired controller displays Ar	Malfunction of temperature sensor of drive electric box of inverter fan
The water heater stops operation and the wired controller displays U9	Zero-crossing protection of drive AC input of inverter fan
The water heater stops operation and the wired controller displays EE	Malfunction of storage chip of main control



Please contact the NORDCEL appointed service center in case of any of following conditions.

Malfunction phenomenon	Malfunction analysis
There's harsh sound during operation; There's off-flavor during operation; Air switch or leakage protection switch breaks off frequently.	There may be risk for the safety. Please stop operation immediately and cut off the power.

**After-sales service**

If there's quality or other problems for the NORDCEL products, please contact with NORDCEL local appointed maintenance center.





66129929934